





SKU: NV4281

-  VOLT Stainless Steel Needle Valve - BSPP, BSPT & NPT
-  VOLTE delstahl Nadelventil - BSPP , BSPT und NPT
-  VOLT Válvula de aguja de acero inoxidable - BSPP , BSPT y NPT
-  VOLT Stainless Steel Needle Valve - BSPP , BSPT et NPT

**Valves**<sup>™</sup>  
O N L I N E

- 1/4" - 1" Stainless Steel Needle Valve with Bar Operator
- 1/4" - 1" Edelstahl Nadelventil mit Bar Operator
- 1/4" - 1" Válvula de aguja de acero inoxidable con bar operador
- 1/4" - 1" Stainless Steel Needle Valve avec Bar opérateur



- **6000 PSI Rated**
- **-29°C to 230°C**
- **Bar Hand Operated**
- **Fluids: Air, Gas, Oil, Steam & Water**

#### **Description:**

Screwed in BSPP, BSPT and NPT our Needle valve range offers precise regulation of flows for air, gasses and liquid applications.

### Stainless Steel Needle Valve



#### Description

Precision needle valves are widely used in instrumentation and hydraulics applications. Allowing precise regulation of flow ensuring positive leak tight shut off.



#### Beschreibung

Präzisions- Nadelventile sind weit verbreitet in der Instrumentierung und Hydraulikanwendungen eingesetzt. Eine präzise Regulierung der Strömung gewährleistet positive dichte Absperren







#### Descripción

Válvulas de aguja de precisión se utilizan ampliamente en aplicaciones de instrumentación y la hidráulica . Permitir que la regulación precisa de flujo asegurando fuga positivo cierre hermético



#### Description

Vannes à poiteau de précision sont largement utilisés dans les applications d'instrumentation et de l'hydraulique . Permettant une régulation précise de l'écoulement assurant fuite positif fermeture étanche

-  VOLT Stainless Steel Needle Valve - BSPP, BSPT & NPT
-  VOLTE delstahl Nadelventil - BSPP , BSPT und NPT
-  VOLT Válvula de aguja de acero inoxidable - BSPP , BSPT y NPT
-  VOLT Stainless Steel Needle Valve - BSPP , BSPT et NPT

## Stainless Steel Needle Valve

- **6000 PSI Rated**
- **-29°C to 230°C**
- **Bar Hand Operated**
- **Fluids: Air, Gas, Oil, Steam & Water**

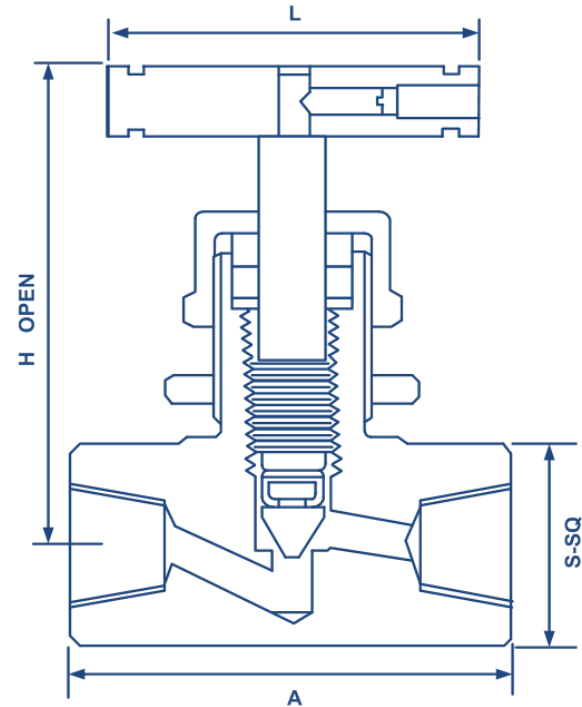

Dimensions					
DN	A	S-SQ	H	L	Kg
1/4"	50	22	69	50	0.29
3/8"	50	25	69	60	0.29
1/2"	68	30	83	60	0.72
3/4"	70	36	83	70	0.93
1"	88	45	102	70	1.24

**THREADS**  
**BSPT**  
**BSPP**  
**NPT**

Materials	
Body	A479-316
Panel Nut	A479-316
Stem	A479-316
Packing	PTFE
Washer	A479-316
Gland Nut	A479-316
Grub Screw	Stainless Steel Plated
Handle	Stainless Steel
V-Tip	17-4 PH